

WELD 45° ELBOWS

*MATERIAL: 304/L

*TUBE FINISH: TUMBLED



Catalogue PN	Size	Wall Thickness	A	B
BW-45EL-050	1/2"	1.65	7.95	19.10
BW-45EL-075	3/4"	1.65	11.91	28.60
BW-45EL-100	1.0"	1.65	15.77	38.10
BW-45EL-150	1.5"	1.65	23.67	57.15
BW-45EL-200	2.0"	1.65	31.57	76.20
BW-45EL-250	2.5"	1.65	39.70	95.25
BW-45EL-300	3.0"	1.65	47.35	114.30
BW-45EL-400	4.0"	2.11	63.12	152.40

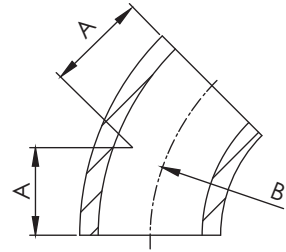

WELD 45° ELBOWS with TANGENTS

*MATERIAL: 304/L

*TUBE FINISH: TUMBLED



Catalogue PN	Size	Wall Thickness	A	B
BW-45ELT-075	3/4"	1.65	19.40	28.60
BW-45ELT-100	1.0"	1.65	30.18	38.10
BW-45ELT-150	1.5"	1.65	41.28	57.15
BW-45ELT-200	2.0"	1.65	58.72	76.20
BW-45ELT-250	2.5"	1.65	76.20	95.25
BW-45ELT-300	3.0"	1.65	93.70	114.30
BW-45ELT-400	4.0"	2.11	122.20	152.40

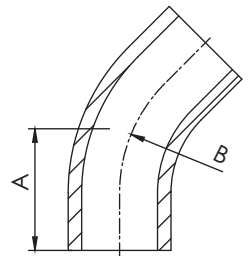

WELD 90° ELBOWS

*MATERIAL: 304/L

*TUBE FINISH: TUMBLED



Catalogue PN	Size	Wall Thickness	A	B
BW-90EL-050	1/2"	1.65	19.10	19.10
BW-90EL-075	3/4"	1.65	28.60	28.60
BW-90EL-100	1.0"	1.65	38.10	38.10
BW-90EL-150	1.5"	1.65	57.15	57.15
BW-90EL-200	2.0"	1.65	76.20	76.20
BW-90EL-250	2.5"	1.65	95.25	95.25
BW-90EL-300	3.0"	1.65	114.30	114.30
BW-90EL-400	4.0"	2.11	152.40	152.40

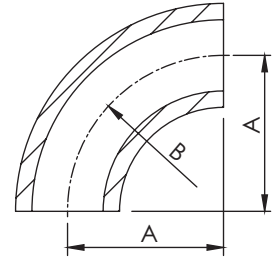

WELD 90° ELBOWS with TANGENTS

*MATERIAL: 304/L

*TUBE FINISH: TUMBLED



Catalogue PN	Size	Wall Thickness	A	B
BW-90ELT-075	3/4"	0.89	36.07	25.40
BW-90ELT-075-L	3/4"	1.65	64.78	28.60
BW-90ELT-100	1.0"	1.65	46.23	38.10
BW-90ELT-100L	1.0"	1.65	52.40	38.10
BW-90ELT-150	1.5"	1.65	61.21	57.15
BW-90ELT-150L	1.5"	1.65	74.60	57.15
BW-90ELT-200	2.0"	1.65	103.12	76.20
BW-90ELT-250	2.5"	1.65	131.83	95.25
BW-90ELT-300	3.0"	1.65	160.30	114.30
BW-90ELT-400	4.0"	2.11	211.07	152.40

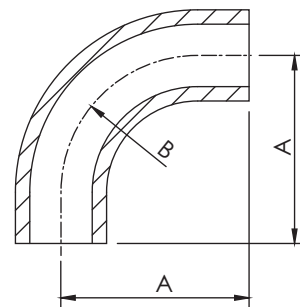

WELD 90° MITERED ELBOWS

*MATERIAL: 304/L

*TUBE FINISH: TUMBLED

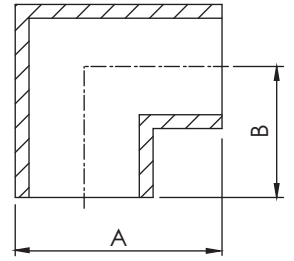

Catalogue PN	Size	Wall Thickness	A	B
BW-MEL-075	3/4"	1.65	34.93	25.40
BW-MEL-075L1	3/4"	1.65	45.08	35.56
BW-MEL-075L2	3/4"	1.65	45.63	36.10
BW-MEL-100	1.0"	1.65	60.20	47.50
BW-MEL-100L1	1.0"	1.65	60.45	47.75
BW-MEL-100L2	1.0"	1.65	58.90	46.20
BW-MEL-150	1.5"	1.65	76.20	57.15
BW-MEL-150L	1.5"	1.65	80.26	61.21
BW-MEL-200	2.0"	1.65	91.44	66.04
BW-MEL-200L1	2.0"	1.65	101.30	75.90
BW-MEL-200L2	2.0"	1.65	102.10	76.70
BW-MEL-200L3	2.0"	1.65	101.60	76.20
BW-MEL-250	2.5"	1.65	107.95	76.20
BW-MEL-250L1	2.5"	1.65	127.00	95.25
BW-MEL-250L2	2.5"	1.65	108.05	76.30
BW-MEL-300	3.0"	1.65	120.65	82.55
BW-MEL-300L	3.0"	1.65	113.50	75.40
BW-MEL-400	4.0"	2.11	149.35	98.55
BW-MEL-400L	4.0"	2.11	174.50	123.70
BW-MEL-600	6.0"	2.11	230.12	153.92

WELD EQUAL TEES

*MATERIAL: 304/L

*TUBE FINISH: TUMBLED



Catalogue PN	Tube OD	Wall Thickness	A	B
BW-ET-050	1 / 2"	1.65	38.10	19.05
BW-ET-075	3 / 4"	1.65	50.80	25.40
BW-ET-075L1	3 / 4"	1.65	72.40	36.20
BW-ET-075L2	3 / 4"	1.65	95.20	47.60
BW-ET-100	1.0"	1.65	91.40	45.70
BW-ET-100L	1.0"	1.65	95.20	47.60
BW-ET-150	1.5"	1.65	114.40	57.20
BW-ET-150L	1.5"	1.65	122.42	61.21
BW-ET-200	2.0"	1.65	132.58	66.29
BW-ET-200L	2.0"	1.65	152.40	76.20
BW-ET-250	2.5"	1.65	152.40	76.20
BW-ET-250L1	2.5"	1.65	163.40	81.70
BW-ET-250L2	2.5"	1.65	190.24	95.12
BW-ET-300	3.0"	1.65	165.20	82.60
BW-ET-300L	3.0"	1.65	183.40	91.70
BW-ET-400	4.0"	2.11	196.80	98.40
BW-ET-400L1	4.0"	2.11	203.40	101.70
BW-ET-400L2	4.0"	2.11	247.56	123.78
BW-ET-600	6.0"	2.77	254.00	127.00
BW-ET-600L	6.0"	2.11	307.80	153.90

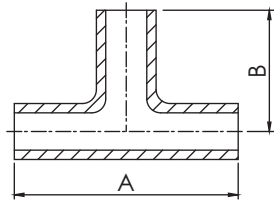

WELD CONICAL REDUCERS

*MATERIAL: 304/L

*TUBE FINISH: TUMBLED



Catalogue PN	Tube OD	Wall Thickness	A
BW-CRN-100x050	1.0" x 1/2"	1.65 x 1.65	34.90
BW-CRN-100x075	1.0" x 3/4"	1.65 x 1.65	34.90
BW-CRN-150x050	1.5" x 1/2"	1.65 x 1.65	60.30
BW-CRN-150x075	1.5" x 3/4"	1.65 x 1.65	60.30
BW-CRN-150x100	1.5" x 1.0"	1.65 x 1.65	60.30
BW-CRN-200x100	2.0" x 1.0"	1.65 x 1.65	60.30
BW-CRN-200x150	2.0" x 1.5"	1.65 x 1.65	60.30
BW-CRN-250x150	2.5" x 1.5"	1.65 x 1.65	60.30
BW-CRN-250x200	2.5" x 2.0"	1.65 x 1.65	60.30
BW-CRN-300x150	3.0" x 1.5"	1.65 x 1.65	92.10
BW-CRN-300x200	3.0" x 2.0"	1.65 x 1.65	92.10
BW-CRN-300x250	3.0" x 2.5"	1.65 x 1.65	92.10
BW-CRN-400x150	4.0" x 1.5"	2.11 x 1.65	92.10
BW-CRN-400x200	4.0" x 2.0"	2.11 x 1.65	92.10
BW-CRN-400x250	4.0" x 2.5"	2.11 x 1.65	92.10
BW-CRN-400x300	4.0" x 3.0"	2.11 x 1.65	92.10

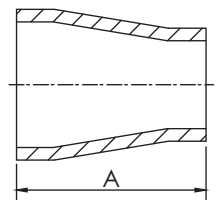

WELD REDUCING TEES

*MATERIAL: 304/L

*TUBE FINISH: TUMBLED



Catalogue PN	Tube OD	Wall Thickness	A	B
BW-RT-100x050	1.0" x 1/2"	1.65 x 1.65	95.50	25.40
BW-RT-100x075	1.0" x 3/4"	1.65 x 1.65	95.50	28.45
BW-RT-150x050	1.5" x 1/2"	1.65 x 1.65	114.30	31.75
BW-RT-150x075	1.5" x 3/4"	1.65 x 1.65	114.30	35.05
BW-RT-150x075L	1.5" x 3/4"	1.65 x 0.89	114.30	35.05
BW-RT-150x100	1.5" x 1.0"	1.65 x 1.65	114.30	54.10
BW-RT-200x050	2.0" x 1/2"	1.65 x 1.65	152.40	38.10
BW-RT-200x075	2.0" x 3/4"	1.65 x 1.65	152.40	41.40
BW-RT-200x100	2.0" x 1.0"	1.65 x 1.65	152.40	60.30
BW-RT-200x150	2.0" x 1.5"	1.65 x 1.65	152.40	63.50
BW-RT-250x150	2.5" x 1.5"	1.65 x 1.65	152.40	69.85
BW-RT-250x200	2.5" x 2.0"	1.65 x 1.65	152.40	82.55
BW-RT-300x150	3.0" x 1.5"	1.65 x 1.65	165.10	76.20
BW-RT-300x200	3.0" x 2.0"	1.65 x 1.65	165.10	88.90
BW-RT-300x250	3.0" x 2.5"	1.65 x 1.65	165.10	82.55
BW-RT-400x150	4.0" x 1.5"	2.11 x 1.65	197.10	88.90
BW-RT-400x200	4.0" x 2.0"	2.11 x 1.65	197.10	101.60
BW-RT-400x250	4.0" x 2.5"	2.11 x 1.65	197.10	95.25
BW-RT-400x300	4.0" x 3.0"	2.11 x 1.65	197.10	95.25
BW-RT-600x150	6.0" x 1.5"	2.11 x 1.65	254.00	114.30
BW-RT-600x200	6.0" x 2.0"	2.11 x 1.65	254.00	127.00
BW-RT-600x250	6.0" x 2.5"	2.11 x 1.65	254.00	120.65
BW-RT-600x300	6.0" x 3.0"	2.11 x 1.65	254.00	120.65
BW-RT-600x400	6.0" x 4.0"	2.11 x 2.11	254.00	123.95

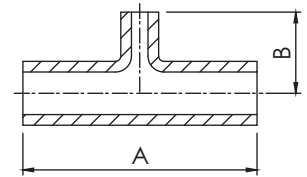

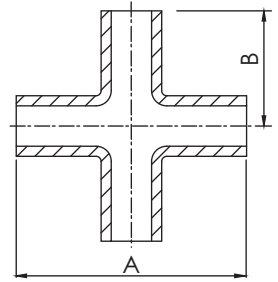

WELD 4-WAY EQUAL CROSSES

*MATERIAL: 304/L

*TUBE FINISH: TUMBLED

Catalogue PN	Tube OD	Wall Thickness	A	B
BW-4C-050	1/2"	1.65	38.10	19.05
BW-4C-075	3/4"	1.65	50.80	25.40
BW-4C-075L1	3/4"	1.65	71.20	35.60
BW-4C-075L2	3/4"	1.65	95.20	47.60
BW-4C-100	1.0"	1.65	95.20	47.60
BW-4C-100L	1.0"	1.65	91.40	45.70
BW-4C-150	1.5"	1.65	114.40	57.20
BW-4C-150L	1.5"	1.65	121.42	60.71
BW-4C-200	2.0"	1.65	152.40	76.20
BW-4C-200L	2.0"	1.65	131.60	65.80
BW-4C-250	2.5"	1.65	152.40	76.20
BW-4C-250L	2.5"	1.65	190.50	95.25
BW-4C-300	3.0"	1.65	160.28	80.14
BW-4C-300L	3.0"	1.65	165.20	82.60
BW-4C-400	4.0"	2.11	196.80	98.40
BW-4C-400L	4.0"	2.11	247.40	123.70
BW-4C-600	6.0"	2.77	254.00	127.00
BW-4C-600L	6.0"	2.77	307.80	153.90

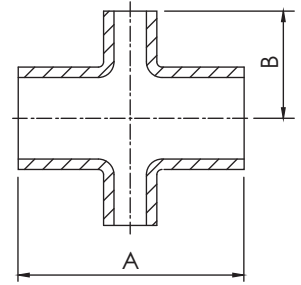

WELD 4-WAY REDUCING CROSSES

*MATERIAL: 304/L

*TUBE FINISH: TUMBLED

Catalogue PN	Tube OD	Wall Thickness	A	B
BW-4RC-100x050	1.0"x1/2"	1.65x1.65	95.50	25.40
BW-4RC-100x075	1.0"x3/4"	1.65x1.65	95.50	28.45
BW-4RC-150x050	1.5"x1/2"	1.65x1.65	114.30	31.75
BW-4RC-150x075	1.5"x3/4"	1.65x1.65	114.30	35.05
BW-4RC-150x100	1.5"x1.0"	1.65x1.65	114.30	54.10
BW-4RC-200x050	2.0"x1/2"	1.65x1.65	152.40	38.10
BW-4RC-200x075	2.0"x3/4"	1.65x1.65	152.40	41.40
BW-4RC-200x100	2.0"x1.0"	1.65x1.65	152.40	60.45
BW-4RC-200x150	2.0"x1.5"	1.65x1.65	152.40	63.50
BW-4RC-250x150	2.5"x1.5"	1.65x1.65	152.40	69.85
BW-4RC-250x200	2.5"x2.0"	1.65x1.65	152.40	82.55
BW-4RC-300x150	3.0"x1.5"	1.65x1.65	165.10	76.20
BW-4RC-300x200	3.0"x2.0"	1.65x1.65	165.10	88.90
BW-4RC-300x250	3.0"x2.5"	1.65x1.65	165.10	82.55
BW-4RC-400x150	4.0"x1.5"	2.11x1.65	197.10	88.90
BW-4RC-400x200	4.0"x2.0"	2.11x1.65	197.10	101.60
BW-4RC-400x250	4.0"x2.5"	2.11x1.65	197.10	95.25
BW-4RC-400x300	4.0"x3.0"	2.11x1.65	197.10	95.25
BW-4RC-600x150	6.0"x1.5"	2.11x1.65	254.00	114.30
BW-4RC-600x200	6.0"x2.0"	2.11x1.65	254.00	127.00
BW-4RC-600x250	6.0"x2.5"	2.11x1.65	254.00	120.65
BW-4RC-600x300	6.0"x3.0"	2.11x1.65	254.00	120.65
BW-4RC-600x400	6.0"x4.0"	2.11x2.11	254.00	123.95



WELD 5-WAY CROSSES

*MATERIAL: 304/L

*TUBE FINISH: TUMBLED

Catalogue PN	Tube OD	Wall Thickness	A	B
BW-5C-075	3/4"	1.65	50.80	25.40
BW-5C-075L	3/4"-L	1.65	67.30	33.65
BW-5C-100	1.0"	1.65	95.40	47.70
BW-5C-100L	1.0"-L	1.65	91.40	45.70
BW-5C-150	1.5"	1.65	114.40	57.20
BW-5C-200	2.0"	1.65	152.40	76.20
BW-5C-250	2.5"	1.65	152.40	76.20
BW-5C-250L	2.5"-L	1.65	190.26	95.13
BW-5C-300	3.0"	1.65	165.20	82.60
BW-5C-400	4.0"	2.11	197.20	98.60
BW-5C-400L	4.0"-L	2.11	247.40	123.70
BW-5C-600	6.0"	2.77	254.00	127.00
BW-5C-600L	6.0"-L	2.77	307.80	153.90

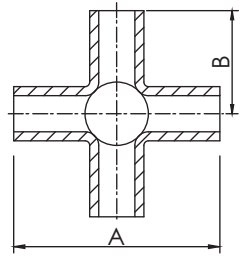

WELD 6-WAY CROSSES

*MATERIAL: 304/L

*TUBE FINISH: TUMBLED

Catalogue PN	Tube OD	Wall Thickness	A	B
BW-6C-075	3/4"	1.65	50.80	25.40
BW-6C-075L	3/4"-L	1.65	67.30	33.65
BW-6C-100	1.0"	1.65	95.40	47.70
BW-6C-150	1.5"	1.65	114.40	57.20
BW-6C-200	2.0"	1.65	152.40	76.20
BW-6C-250	2.5"	1.65	152.40	76.20
BW-6C-250L	2.5"-L	1.65	190.26	95.13
BW-6C-300	3.0"	1.65	165.20	82.60
BW-6C-400	4.0"	2.11	197.20	98.60
BW-6C-400L	4.0"-L	2.11	247.40	123.70
BW-6C-600	6.0"	2.77	254.00	127.00
BW-6C-600L	6.0"-L	2.77	307.80	153.90

